

Full Length Research Paper

Failure rate analyses of cereal combined drills

Sait M. Say^{1*} and Sarp K. Sümer²

¹Cukurova University, Faculty of Agriculture, Department of Agricultural Machinery, 01330, Adana, Turkey.

²Canakkale Onsekiz Mart University, Agricultural Machinery Department, 17020 C.Kale, Turkey.

Accepted 21 August, 2018

Machine availability estimations from research performed before the following season are needed to decide on the required machinery size necessary for timely operation. Additionally, estimations on machinery availability will provide useful data for making mathematically proven assumptions regarding the repair maintenance and timeliness costs. Machine reliability or operational availability analyses must be carried out, especially for combine drills and combine harvesters, which are relatively more sensitive to timeliness. In the literature, there is rare study on operational availability on combine drills. In this study, failure rates, which are a direct indication of machine operational availability, were evaluated from the farm records of cereal combine drills used in Adana, which is located in Çukurova, one of the major agricultural regions in southern Turkey. These records for combine drills of different ages and with different annual use hours were collected during three subsequent years. Moreover, different repair and maintenance policies in farms under examination were considered. As a result, it was found that different accumulated use hours and repair-maintenance policies have slightly affected failure rates. According to the data, the combine drills included in this study are commonly in a randomized breakdown period within their useful life.

Key words: Reliability, combine drill, machine availability, failure rate, timeliness.

INTRODUCTION

One of the most important factors in obtaining the best crop yield is the timeliness of the field operations, as an operation performed at an improper time may cause the loss of potential yield (Ilik, 1990). In other words, under a particular combination of weather, soil type, topography, and other related factors, there is an appropriate time to perform a particular field operation so that both the quality and quantity of a product reaches an optimum level (Kumar and Gross, 1977). On the other hand, agricultural machinery is utilized not only to increase labor productivity but also to meet the deadlines for different farm operations, and farmers, as well as the custom operators, perform different operations according to the machine capacities available. These plans can be disrupted by various unexpected field stoppages if machinery failures are not accounted for in the plans.

The expected repair time for breakdowns is not usually included in the calculation of predicted field efficiency, but such time losses do interfere with machine performance

(Hunt, 1983). Technical and economical factors should be evaluated together to make the best decision regarding the selection of machinery required, and predicted field efficiency is an important aspect of technical consideration (Çiçek and Arın, 2004). Reduced machine performance, combined with the incorrect size selection during the busiest part of the season, can cause delays in the completion of operations and result in the loss of crop yields and inefficient labor utilization. To make allowance for machinery failures in planning, the probability of machine failure needs to be estimated before plans are made. There are very limited studies in relevant literature regarding the analysis of machinery failures. In this literature, failure probabilities of different kinds of machinery were determined, and their effects on cost load, the use of the data in the planning stage were examined (Hunt, 1983; Shoup et al., 1983; Ward et al., 1985; Say and Ilik, 1997).

It is well known that there is a strict relationship between the planting date of cereals and the potential yield, depending on certain agronomic requirements of the seed and environmental conditions (Hunt, 1983). In this study, a failure frequency analysis of cereal planters, which are operated under different farm conditions and

*Corresponding author. E-mail: saitmsay@cu.edu.tr. Tel: +90 322 338 61 95. Fax: +90 322 338 70 61.

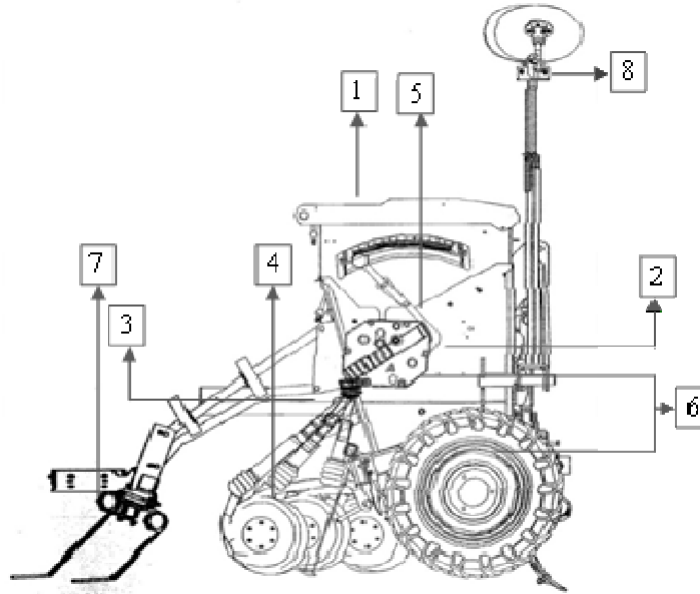

Figure 1. General view of cereal combined drill under investigation.

especially used in wheat planting in Adana province, were made by using regression analysis.

MATERIALS AND METHODS

Materials

Study location

The study was conducted in Adana province (around Ceyhan, Yüre ir, and Karata) located in Çukurova, one of the major agricultural regions in southern Turkey. In Turkey, 70% (8.1×10^6 ha) of the total cereal sowing area (12.07×10^6 ha) belongs to wheat production. The wheat sowing area in Adana is about 0.22×10^6 ha, constituting 2.7% of Turkey's cereal area (TU K, 2010a). The wheat is sown commonly by combined cereal drills, and 1.1% (1 963) of Turkey's number (179 048) is available in Adana Province (TU K, 2010b).

General definition of drills

Failure records were provided from cereal combined drills, which operate different sized (different annual use hours) wheat farms with similar structure and operation principles. The main parts of these drills can be classified as follows (Figure 1):

- 1) Seed and fertilizer hoppers
- 2) Agitator and feed roller (feed mechanism)
- 3) Seed and fertilizer delivery tubes
- 4) Drill coulter and furrow opener
- 5) Transmission mechanism
- 6) Main frame and land-wheels
- 7) Spring teeth and
- 8) Marker mechanism.

Methods

The reliability of a machine is its probability to perform its function

within a defined period with certain restrictions under certain conditions (ASABE, 2006; Billinton and Allan, 1992). A machine's operational availability is the proportional expression of reliability; therefore, it is the period during which a machine can perform its function without any breakdowns (Tufts, 1985). The reliability of any equipment is related to frequency of failures, which is expressed by the "mean time between failures (MTBF)." The parameter defining a machine's reliability is the failure rate (), and this value is the characteristic of breakdown occurrence frequency. Failure rate is equal to the reciprocal of the mean time between failures (MTBF) defined in hours, and its equation is as follows (Tufts, 1985; Billinton and Allan, 1992):

$$= \frac{1}{\text{MTBF}}$$

Failures, in general, can be categorized into three basic types, though there may be more than one contributing cause for a particular failure. The three types are 1) early failures 2) random failures and 3) wear- out failures. Early failures are those that occur due to some defect in the part or the assembly resulting from a design, manufacturing, or inspection deficiency. During the random failure period, the failure rate is usually a constant failure rate. The failures are due to a random occurrence of environmental stress levels sufficiently severe enough to cause component failures. This period in the life of components is also known as "useful life period." The wear out period is characterized by an increase in failure rate due to the degradation of parts with age. The relationship of these three failure classes is shown in Figure 2 (Kumar and Gross, 1977).

The failure data of cereal combined drills was collected during three subsequent years from the same cereal farms selected through survey results from detailed questionnaires administered before the active season. All definable failures causing any delay, excluding those related to rubber tires and clogs in openings of delivery tubes on the soil surface, were recorded along with seasonal accumulated working hours. A sampling number (74) was determined according to the aimed sampling method, which gives the representational enough data, for each given sub-group (Marzillier, 1990). It was widely accepted that the failure frequency of farm machinery was mainly affected by annual working hours, repair-maintenance policies, and operating environment.

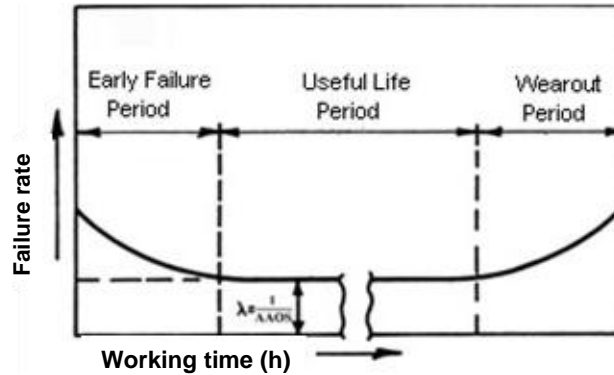

Figure 2. Failure rate curve (bathtub) for an ideal machine or machine part.

Table 1. Some descriptive data related use hours for given sub-groups.

Sub-groups	Average annual use hours (h)	Average age, year	Average accumulated use hours (h)	Machine number
40-80 _{OAS}	62±1.72*	7.0±0.28	434.0±15.00	17
40-80 _{CS}	68±1.55	7.8±0.32	530.4±14.00	25
Averages/ Total	65±1.67	7.4±0.30	481.0±14.50	42
81-120 _{OAS}	90±2.00	6.5±0.20	585.0±29.00	11
81-120 _{CS}	100±2.20	6.9±0.35	690.0±25.00	21
Averages/ Total	95±2.10	6.7±0.27	636.5±27.00	32

*:Standart error=standart deviation/ \sqrt{n} .

Additionally, the storing place during the year is another important factor, since short duration periodic usage in agricultural production and prolonged storage are typical characteristics of agricultural machine operation (Severnev, 1984). In particular, the dimensions and properties of parts during prolonged storage change, as a result of corrosion. For this reason, the open air and closed storage of cereal combined drills were considered in grouping. For this study, 74 cereal combined drills were grouped according to the results of a questionnaire that covered the factors aforementioned. Since it was seen that there was no considerable differences between farms, in terms of operating environment characteristics, such as slope, stony and/or contoured ground, and repair-maintenance policies during the year, the operating environment and repair-maintenance policies were discarded. However, the storing place of the machinery during the year was selected as an effective factor. The relationship between failure rate and accumulated use hours were graphed and analyzed in regression analyses according to the following sub-groups:

- 1) 40 to 80 annual use hours/open-air storage during the year (40 to 80_{OAS}) (25 machines);
- 2) 40 to 80 annual use hours /closed storage during the year (40 to 80_{CS}) (17 machines);
- 3) 81 to 120 annual use hours /open-air storage during the year (81 to 120_{OAS}) (21 machines);
- 4) 81 to 120 annual use hours /closed storage during the year (81 to 120_{CS}) (11 machines).

Failure rate (Equation 1) was calculated based on the accumulated use hours found at the end of each subsequent year for each drill in a given sub-group. In other words, three different failure rates were calculated, providing that at least two and one failure occurrence in

a first and following observation years, respectively for each cereal combined drill. At the end of the second year, the failure rate was found from the time between failures from the first to the second year, as the mean time between failures. Similarly, the last calculated failure rate values at the end of the third observation year (highest accumulated use hours) represented the mean time between failures for the entire three years.

RESULTS AND DISCUSSION

General evaluation of sub-groups

The average annual use hours, average age, and accumulated use hours at the end of third year of cereal combined drills are presented in Table 1 and Figure 3 for the given annual use hours ranges. As depicted in the table, the average annual use hours for 40 to 80 and 81 to 120 main groups were 65 and 95, respectively. According to the daily working hour statistics, machines in the 81 to 120 annual use hours main groups were used almost 3 to 4 days more, compared to the 40 to 80 annual use hours main group in a season. The average age of the machines in the main groups are quite near each other at 7.4 for 40 to 80 and 6.7 for 81 to 120. On the other hand, there is a difference of 155.5 h between the two main groups in terms of average accumulated use hours.

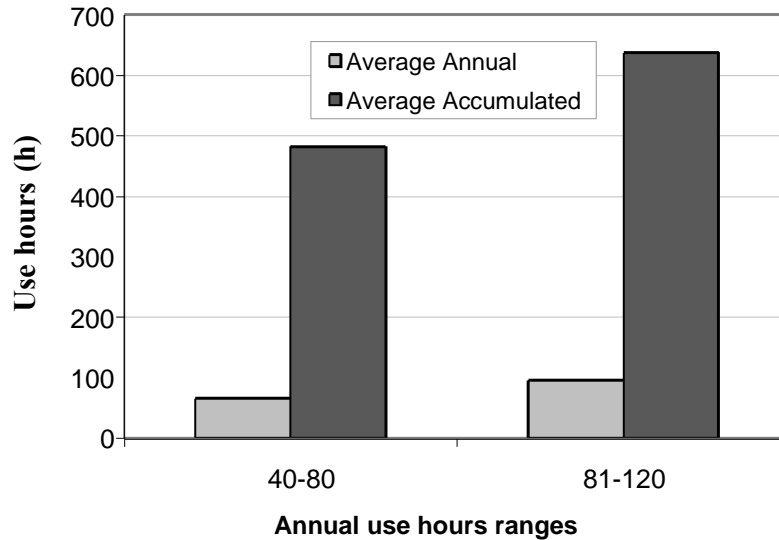

Figure 3. Average annual and accumulated use hours of drills for given annual use hours ranges.

Table 2. Some descriptive statistics of failures encountered in given sub-groups.

Sub-groups	Number of failures			
	Max	Min	Average	Total
40-80 _{OAS}	6	1	3.00±0.4	51
40-80 _{CS}	5	0	2.00±0.3	50
Averages/ Total	5.5	0.5	2.5±0.26	101
81-120 _{OAS}	8	2	4.54±0.40	50
81-120 _{CS}	8	1	4.00±0.30	84
Averages/ Total	8	1.5	4.25±0.28	134
Total 235 failures				
Average 3.2 failures/machine				

Failure data for sub-groups

Table 2 presents descriptive information regarding failure data derived from farm records valid for given sub-groups at the end of the third year. Average failure numbers encountered at the end of the third year for 40 to 80_{OAS}/40 to 80_{CS} and 81 to 120_{OAS}/81 to 120_{CS} sub-groups were 3/2 and 4.54/4 respectively. The maximum failure number for the 40 to 80_{OAS} sub- group was observed at 700 accumulated use hours, while the minimum failure number was observed at 180 accumulated use hours for the same group.

The maximum and minimum failure numbers for the 40 to 80_{CS} sub- group were recorded at 495/135 and 180 accumulated use hours, respectively. The maximum failure number for the 81 to 120_{OAS} sub- group was observed at 720 accumulated use hours, while the minimum failure number was observed at 320 accumulated use hours for same group. The maximum and minimum failure numbers for the 81 to 120_{CS} sub-

group were recorded at 840 and 190 accumulated use hours, respectively. The table shows that average failure numbers considerably increased in sub-groups of 81 to 120 (4.25) compared to the 40 to 80 (2.5) sub-group. Total and average failure numbers recorded for all sub-groups during the three-year period of the study were 235 and 3.2, respectively.

Failure types

Failure types and their distribution as a percentage of total failures recorded are summarized in Table 3. As indicated, the transmission mechanism caused the majority of recorded failures, 43.4% in total. Also, transmission mechanism failures made up the majority in each machine sub-group. The reasons for the failures connected to the transmission mechanism and the agitator and feed roller generally involved breaks on the bearings and ruptures in the chains. Cracking and

Table 3. Failure types and their distribution.

Failure types	Failure numbers				Total	%
	40-80 _{OAS}	40-80 _{CS}	81-120 _{OAS}	81-120 _{CS}		
Transmission mechanism*	23 (45.1%)	19 (38.0%)	20 (40.0%)	40 (47.6%)	102	43.4
Agitator+feed roller	10 (19.6%)	11 (22.0%)	9 (18.0%)	19 (22.6%)	49	20.9
Coulter shaft+lifting brackets	10 (19.6%)	13 (26.0%)	12 (24.0%)	14 (16.7%)	49	20.9
Trailing coulter arm	8 (15.7%)	7 (14.0%)	9 (18.0%)	11 (13.1%)	35	14.8
Total	51 (100.0%)	50 (100.0%)	50 (100.0%)	84 (100.0%)	235	100.1

*: Chain drive+speed change gears.

Table 4. Average failure rates and mean time between failures for sub-groups.

Sub-groups	Average failure rate	Mean time between failures (h)
40-80 _{OAS}	0.033±0.003	30.5±3.47
40-80 _{CS}	0.031±0.002	32.3±1.84
Average	0.032	31.40
81-120 _{OAS}	0.047±0.003	21.3±3.12
81-120 _{CS}	0.040±0.003	25.0±2.02
Average	0.044	23.15

ruptures mostly resulted from variable rate dynamic loads in the coulter shaft and lifting brackets and trailing coulter arm were the other most common failure reason. On the other hand, corrosion, especially for machine stored in the open air, is responsible from most cracking and rupture failures (Severnev, 1984).

Failure rates of sub-groups

The average failure rates and the mean time between failures calculated for all three years are included in Table 4 for all sub-groups. As shown, the average failure rates for the 40 to 80 and 81 to 120 sub-groups were 0.032 and 0.044, respectively, which means that the failure occurrence probability in the 81 to 120 sub-groups (MTBF = 23.15 h) was higher than that of the 40 to 80 sub-groups (MTBF = 31.40 h) in a given period of time. Additionally, the closed storage of the machinery slightly decreased the failure occurrence frequency. Exponential distribution is one of the most common distributions in the evaluation of failure rates (Kumar, 1977; Billinton and Allan, 1992). For this reason, failure rate versus accumulated use hours were modeled according to the exponential relationship of regression.

On the other hand, this modeling gave the highest R^2 values (depicted in each figure) in comparisons of each sub-group to other regression models. The relationship between the calculated failure rate and the accumulated use hours for each sub-group are given in Figures 4, 5, 6, and 7 to provide a detailed evaluation of failure rate trends towards the wearing out period of machines. As Figure 4 indicates, there is a general trend that fits the exponential relationship towards the wearing out period

of machine life for the 40 to 80_{OAS} sub-group. Additionally, cereal combined drills working under given conditions at 700 accumulated use hours were almost in the beginning of wear -out period with a mean time between failures value of 30.5 h.

According to the Figure 5 pattern, cereal combined drills in the 40 to 80_{CS} sub-group were mostly in the useful life period. The randomized failure period, with a mean time between failures value of 32.3 h, is valid due to a closed storing environment and a slightly decreased accumulated use hours comparison to the 40 to 80_{OAS} sub-group. The relationship between failure rates versus accumulated use hours for the 81 to 120_{OAS} sub-group was depicted in Figure 6. It shows that cereal combined drills in this sub-group tend to enter the wear-out period with a mean time between failures value of 21.3 h.

Lastly, the 81 to 120_{CS} sub-group with a mean time between failures value of 25.0 provides an obvious indication of wear-out period entrance based on the exponential regression model. Machines in the 80 to 120 annual use main group were obviously in a nearer position to the wear-out period, than that of the 40 to 80 annual use main group, since increased annual use hours have an effect on failure frequency increase.

Conclusion

In accordance with the data obtained from this study, it can be emphasized that increase in annual use hours and open air storage conditions slightly increased the failure rate values. Failure rate values give an idea about the machine reliability which has an economic meaning in terms of timeliness of the agricultural operations. On the

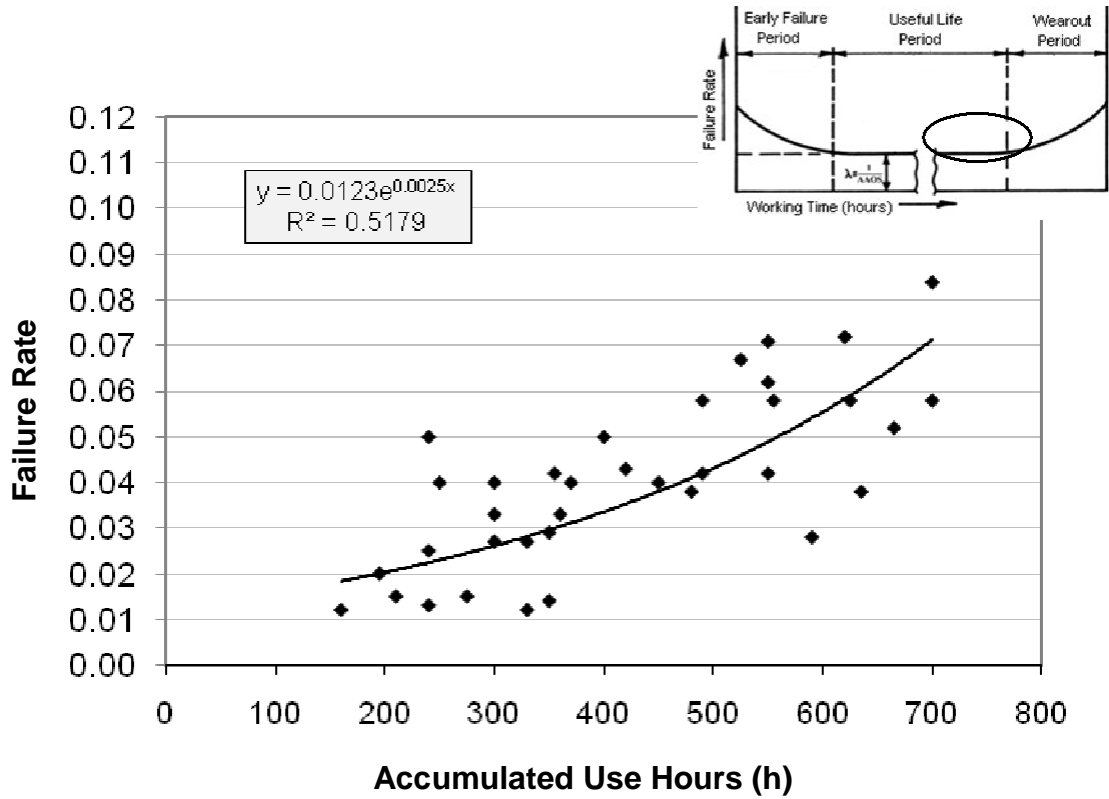

Figure 4. Calculated failure rate vs accumulated use hours for 40 to 80oas sub-group.

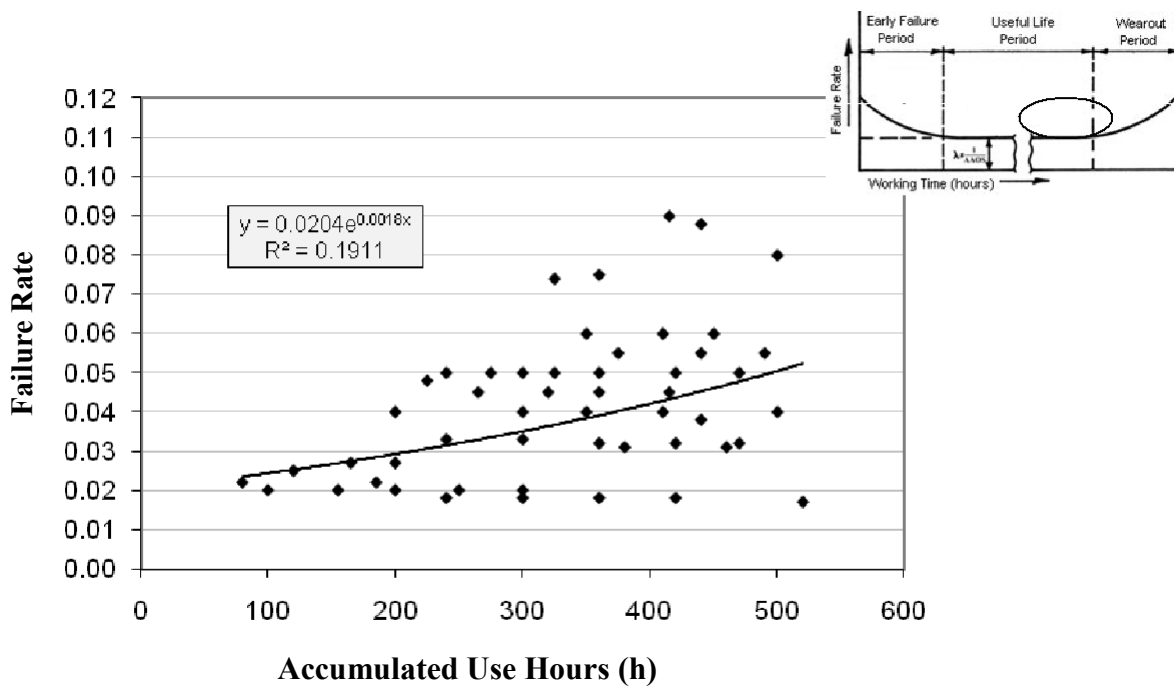

Figure 5. Calculated failure rate vs accumulated use hours for 40-80cs sub-group.

other hand, repair maintenance costs, having a remarkable share on total costs, are highly interrelated

with failure pattern of agricultural machinery. Failure frequencies and its delay effect on planned working hours

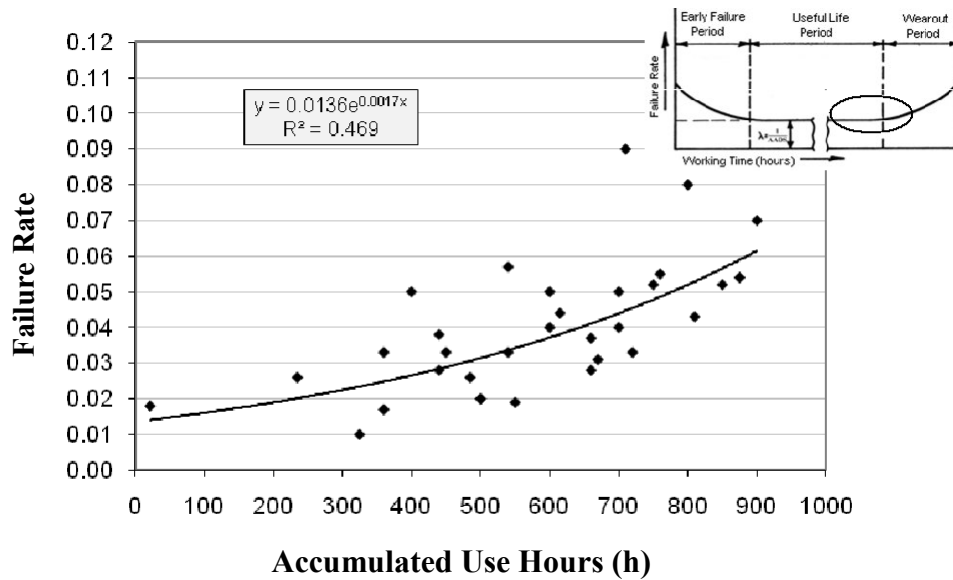

Figure 6. Calculated failure rate vs accumulated use hours for 81-120_{oAS} sub-group.

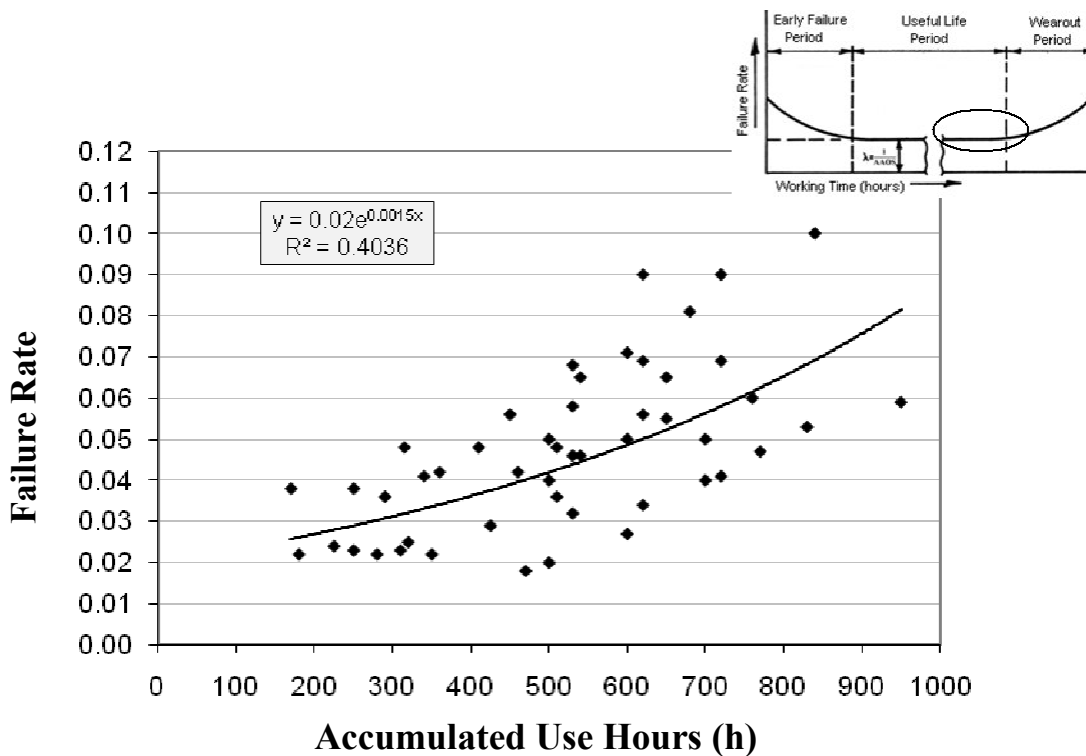

Figure 7. Calculated failure rate vs accumulated use hours for 81-120_{cs} sub-group.

have crucial importance in estimating the required total implement width before season. The trends of failure rate values versus accumulated use hours, which are derived from related graphs, give an indication in which life period the machinery is.

Additionally, by using the data derived from these graphs, accurate spare part planning reducing delay time

in active season and replacement time of the machinery can be more reliably decided. It should be clearly stated that, homogenous machinery sub groups covering almost all possible effective factors on failure pattern of agricultural machinery is quite important, to get applicable results with higher accuracy. For achieving this, a well designed record and analysis system should be

developed. Since very limited study was carried out on failure rate changes of agricultural machinery for subsequent years, this study will give a new approach to analyze and use it in multipurpose management decisions.

ACKNOWLEDGEMENT

This research was supported by Academic Research Projects (Project no: ZF/2003/BAP12) of Cukurova University.

REFERENCES

- ASABE (2006). ASABE standards -test and reliability guidelines, ASAE EP496.3. American Society of Agricultural Engineers. St. Joseph, MI., pp. 49085-49659.
- Billinton R, Allan RN (1992). Reliability evaluation of engineering systems (concepts and techniques). Plenum Press, New York, London. 453 pp.
- Çiçek G, Arın S (2004). Örnek bir çeltik i letmesinde kullanılması gereken tarım makinaları büyüklükleri ve sayılarının do rusal programlama yöntemiyle tespiti (in Turkish). Tarım Bilimleri Dergisi, 10(1): 116-120.
- Hunt D (1983). Farm power and machinery management. Iowa State University Press, 352 pp.
- İ ık A (1990). Zamanlılık analizleri ve tarım makinelerinin seçimi (in Turkish). Ç.Ü. Ziraat Fakültesi Dergisi, 5(3): 59-68.
- Kumar RJ, Gross R (1977). A study of combine harvester reliability. Transactions of the ASAE, 20(1): 30-34.
- Marzillier LF (1990). Elementary statistics. Wm. C. Brown Publishers. ISBN 0-697-05931-3, 500 pp.
- Say SM, İ ık A (1997). Tarım makinalarıyla çalı mada arızalanma oranı ve güvenilirlik de erlerinin belirlenmesi (in Turkish). Tarımsal Mekanizasyon 17. Ulusal Kongresi 17-19 Eylül 1997, pp. 130-137.
- Severnev MM (1984). Wear of Agricultural Machine Parts. Kolos Publishers, Leningrad, 259 pp.
- Shoup WD, Allbritton MK, Snaw LN (1983). Machine reliability guidelines for citrus and vegetable equipment. ASAE Paper No. 83-1082, p. 21.
- Tufts RA (1985). Failure cause, frequency, and repair for forest harvesting equipment. Trans. ASAE, 28 (4):1673-1677.
- TUIK (2010a). Bitkisel Üretim istatistikleri (in Turkish). (Governmental Statistical Institute of Türkiye). Access: [http:// www.tuik.gov.tr](http://www.tuik.gov.tr).
- TUIK (2010b). Tarım alet ve makine sayıları (in Turkish). (Governmental Statistical Institute of Türkiye). Access: [http:// www.tuik.gov.tr](http://www.tuik.gov.tr).
- Ward SM, Cunney MB, McNulty PB (1985). Repair costs and reliability of silage mechanisation systems. Trans. ASAE, 28(3): 722-725.